

Idea Bain-marie, four wells (4GN) with wheels H=750mm, overshelf with LED lights

ITEM # _____

MODEL # _____

NAME # _____

SIS # _____

AIA # _____

**322053 (F02H4KW02S)**

Bain-marie on cupboard, four wells (4 GN container capacity) with wheels, overshelf with LED lights and two stainless steel tray sliders, H=750mm (Nordic)

Short Form Specification

Item No.

Compact design, ideal for space saving environments. AISI 304 Foldable tray sliders on long sides. Unit mounted on 125 mm wheels 2 swivel and 2 with brakes. Soft closing doors on operator side. Underneath ambient cupboard with doors. A type AISI 304 overshelf equipped with LED lights designed for extra increased visibility on the surface for charming food display. Sleek, minimalist glass structure, food and dust does not get trapped and easy to clean. Curved glass. Sturdy body construction with laminated panelings on 4 sides. Designed to serve the food in gastronorm containers with a maximum height of 200mm. Electronic overheating protection. Digital control with temperature display with precise adjustment (0,1° C). Fully compliant HACCP digital controls include visible alarms. Designed to work with both hot and cold water. Etched foil heating elements to maximize heat transmission for reduced warm-up times. Equipped with separated GN 1/1 wells to minimize water and electricity usage allowing to operate only the needed wells. Each well can be switched on/off independently. Wells in 304 AISI stainless steel with rounded corners to facilitate cleaning operations. The wells are also equipped with a drain hole. Wells bottom are inclined to guarantee full well drainage. 19mm thick glass wool isolated with galvanize sheet guarantees excellent well insulation to reduce energy dispersion. Heating elements connected to the well bottom include safety thermostat. Food introduced at the correct temperature maintains its core temperature according to Afnor Standards. 750mm worktop height.

APPROVAL: _____

Main Features

- Electronic overheating protection.
- Designed to serve the food in gastronorm containers.
- Suitable for GN 1/1 containers with a maximum height of 200 mm.
- Precise temperature control and setting at 0,1° C .
- As standard the product comes with digitally controlled thermostat which is in line of HACCP norms and provides visual alarm as a warning of the increasing or decreasing temperatures.
- It is possible to transform one of the GNs to soup dispenser with the available accessory.
- Available drop-in dimensions: 2, 3, 4 GN.
- Wells bottom are inclined to guarantee full well drainage.
- Perfect compact design makes it ideal for space saving environments.
- CB and CE certified by a third party notified body.
- Soft closing doors on operator side.
- Underneath ambient cupboard with doors ideal for extra storage.
- Available options with online configurator: colors, tray sliders, overshelves, feet/wheels with desired diameter, height 750mm for kids.
- Overshelf equipped with LED lights.
- Optional plinth can be installed to cover the feet or the wheels.
- AISI 304 Tray slider in flush mounted stainless steel is installed on long sides and they can also be folded down to facilitate passage of the units through doorways.
- Ideal for servery lines without an operator.
- Unit mounted on 125 mm wheels 2 swivel and 2 with brakes.
- Stylish A type overshelf designed for extra increased visibility on the surface for charming food display.
- Curved glass.
- Food introduced at the correct temperature maintains its core temperature according to Afnor Standards.
- Available dimensions: 2, 3, 4 GN.
- Thanks to the sleek, minimalist glass structure, food and dust does not get trapped and the cleaning is made easier.
- Designed to work with both hot and cold water.

Construction

- Heating elements connected to the well bottom include safety thermostat.
- IPx4 water protection.
- Electronic control with temperature display.
- Overshelf in complete AISI 304.
- Top in AISI 304.
- Sturdy construction with laminated panelings on 4 sides.
- Well in 304 AISI stainless steel with rounded corners to facilitate cleaning operations. The well is also equipped with a drain hole.

Sustainability

- 19mm thick rock wool isolated with galvanize sheet guarantees excellent well insulation to reduce energy dispersion.
- Etched foil heating elements to maximize heat transmission



Idea Bain-marie, four wells (4GN) with wheels H=750mm, overshelf with LED lights

for reduced warm-up times.

- Equipped with separated GN 1/1 wells to minimize water and electricity usage allowing to operate only the needed wells. Each well can be switched on/off independently.



Idea
Bain-marie, four wells (4GN) with wheels H=750mm, overshelf with LED lights
The company reserves the right to make modifications to the products without prior notice. All information correct at time of printing.

2025.02.13

Front

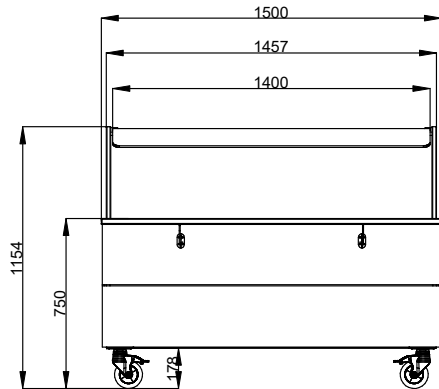

Side

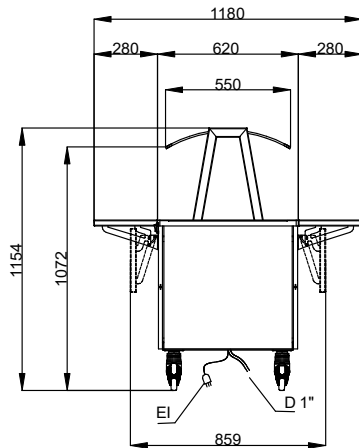

D = Drain
EI = Electrical inlet (power)

Top

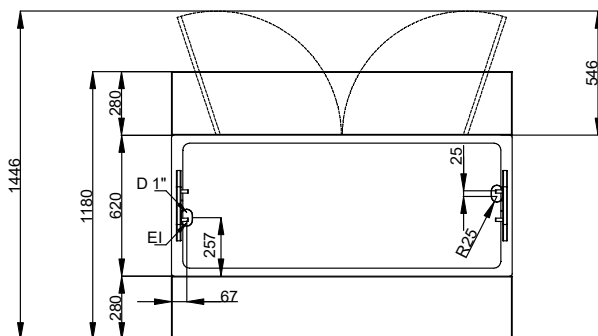

Electric

Supply voltage:
322053 (F02H4KW02S) 380-410 V/3N ph/50/60 Hz
Electrical power max.: 4.04 kW

Water:

Water drain outlet size: 3/4"

Key Information:

N° of doors: 2
External dimensions, Width: 1500 mm
External dimensions, Depth: 1180 mm
External dimensions, Height: 1154 mm
Net weight: 144.5 kg
Shipping height: 1410 mm
Shipping width: 920 mm
Shipping depth: 1550 mm
Shipping volume: 2.01 m³
Set temperature: +85 / +95 °C

Sustainability

Noise level: 45 dBA